

# CANNONDALE® EASY RIDER™ RECUMBENT BICYCLE OWNER'S MANUAL SUPPLEMENT



**READ THIS MANUAL CAREFULLY!**  
It contains important safety information.

## TABLE OF CONTENTS

<b>EASY RIDER CABLE ROUTING.....</b>	<b>2</b>	Shifter Choice and Positioning	19
<b>SOME RECUMBENT-SPECIFIC RIDING</b>		Mid-Drive / Mid-Drive Bearing	19
<b>CHARACTERISTICS.....</b>	<b>4-7</b>	Front Chain Tensioner	20
<b>SET UP AND ADJUSTMENT.....</b>	<b>8-10</b>	Chainring Bolts	21
Frame Size	8	Front Derailleur Adjustment	21
The Seat	8	Brake Set Up	21
The Handlebars and Stem	10	<b>CARRYING STUFF.....</b>	<b>21</b>
<b>MECHANICAL ADJUSTMENTS.....</b>	<b>11-21</b>	<b>ACCESSORIES.....</b>	<b>22</b>
Holding the Bike in a Work Stand	11	<b>TRANSPORTATION.....</b>	<b>23</b>
Suspension Set Up	11	<b>REFERENCES.....</b>	<b>23</b>
Easy Rider Fork	12	<b>CANNONDALE WARRANTY .....</b>	<b>24</b>
Preload Adjustment	13	<b>CONTACT INFORMATION.....</b>	<b>24</b>
HeadShok Scheduled Maintenance	16		
HeadShok Warranty	18		
Fox Rear Shock Service and Warranty	18		
Tire Choice and Pressure	18		

**cannondale**  
HANDMADE IN USA

## CANNONDALE EASY RIDER CABLE ROUTING

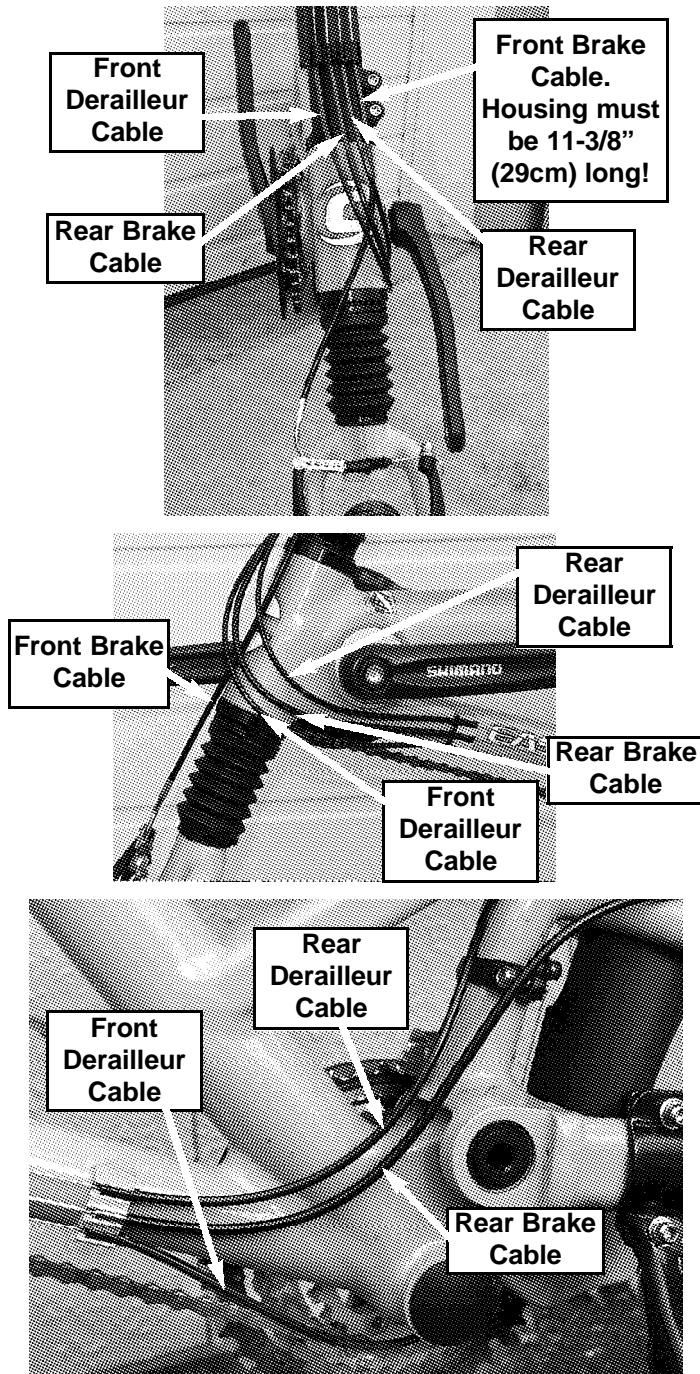

Thanks for purchasing the most sophisticated, comfortable and well crafted Mid Wheelbase (MWB) recumbent.

Please take the time to read and understand this Owners Manual supplement, the Cannondale Bicycle Owners Manual and any other literature included with the bike. All contain important safety warnings and performance tips. If you have any questions about your bicycle or the content of any of this literature please contact Cannondale.

Your Easy Rider should have included *both* a standard owner's manual and this supplement. If you did not receive both of these documents, please download and print one from the Cannondale website Tech Center or call our customer service line at 1-800-BIKE-USA in the U.S. or Canada to have one sent to you. See the back page for other phone numbers and e-mail contacts.

**WARNING: A Recumbent bicycle is different from a conventional bicycle. To help avoid serious or fatal injury and to minimize risk you must learn and practice new skills. Before riding, read this Recumbent Owners Manual Supplement, and learn and practice the skills described below.**

Note that a manual alone cannot teach you how to ride, and a manual the size of an encyclopedia could not cover every combination of bicycle, rider and conditions. Thus, as a reasonable person would expect, our manuals focus on the bicycle and important cautions and warnings, not on teaching you how to ride.

Many hazards are described in the warnings, and we have attempted to explain how to avoid or minimize the hazards. Because any fall or crash can result in serious injury or even death we do not repeat the warning of these potential consequences every time we call attention to a hazard. The reality is that the exact nature of the consequences is not predictable.

**WARNING**

TO HELP AVOID SERIOUS OR FATAL INJURY, FOLLOW THESE SAFETY RULES:

Wear a helmet at all times when riding.

Before riding, read your Owner's Manual and Owner's Manual supplements.

A recumbent bicycle is different from a conventional bicycle. To minimize risk, you must learn and practice new skills. Before riding, read the recumbent Owner's Manual supplements.

Like other high-performance structures, the frame, fork and components should be inspected periodically for cracks. DO NOT ride a bike with any crack. See your authorized Cannondale retailer, call us at (800) BIKE USA, or visit us at [www.cannondale.com](http://www.cannondale.com)

Meets or exceeds applicable:  
CPSC-1512 ISO-4210 BS-6102-1981

202011

## SOME RECUMBENT-SPECIFIC RIDING CHARACTERISTICS

**Handling:** Recumbents have handling characteristics that are different from conventional bicycles, and the Cannondale Easy Rider may handle differently than other recumbents you may have ridden. Take time to become familiar and comfortable by doing practice rides in safe, open, level areas with little or no traffic.

**Starting off:** Getting your recumbent started is a basic skill you must master. Make sure you are in a moderate gear (with the chain on the middle chainring and the middle of the cassette). Position the pedal under your stronger or favored leg with the crank arm straight up (at 12 o'clock). Be sure your path is clear. Relax your arms and lean against the seat back. Give a strong push with this leg and promptly get your other foot off the ground and then patiently position the other foot on the other pedal. It is very helpful to learn this skill with the seat further forward than you may ultimately place it. Err on the side of a closer seat until starting off is second nature. This shorter pedal-to-seat back position and more upright seat back will allow you to use your legs in a more controlled, knees bent position and minimize the tendency that most people have to hunch forward towards the handlebars.

**Slow speed maneuvering:** You will find that as you practice tight turns and small circles at walking speeds, the handlebars can come close to your knees, your inside hand grip will get closer to your body and your outside hand grip will move away from your body. Recumbent enthusiasts call this the "tiller effect". Make adjustments (See the SET UP AND ADJUSTMENT section below) and get used to these characteristics. Remember that these characteristics are not significant once you start to ride even a little faster but are significant when maneuvering slowly.

**Coming to a stop:** This is easier than on a conventional bicycle, but you will want to practice. As you brake to a stop (see important braking section below) take one foot off the pedal, and then the other. As your feet come close to touching the ground be sure you are going very slowly –slower than walking – and that your heel is down and your toe is up. If you are going too fast, or try to use your feet as brakes, you may catch the ground with your foot and injure your foot or leg.

**Braking:** This recumbent has great braking power, and it is easier to use this power than it is on a conventional bicycle. Braking characteristics have a lot to do with weight distribution and weight transfer. When you apply brakes, weight

shifts forward. On a conventional bicycle you have long been taught respect for the power of front brakes and the need to modulate their use to avoid pitching yourself over the handlebars (See section 4 C of the Cannondale Owners Manual). You also have been taught that applying a lot of rear brake will result in a skid, with little effect on reducing speed.

On this recumbent your weight is relatively lower and much more to the rear. This means you can use much more rear brake power without skidding the rear tire. You can brake harder without the hazard of pitching yourself over the handlebars. In a panic braking situation think, "rear brake hard!"

The front tire of this recumbent is lightly loaded. If you use the front brake too hard for the circumstances you can cause a skid, lose control, and crash. In particular, do not apply too much front braking force when the front wheel is turned or on a loose or slippery surface. Do not over-inflate the front tire (see Front Tire Pressure section below) as over-inflation will minimize the tire contact patch and decrease potential braking power.

**Maintaining a course:** The front wheel is relatively small. It is also relatively light. These characteristics mean that it has less gyroscopic effect than the larger front wheel on a conventional bicycle. The gyroscopic effect of a front wheel adds stability to a bicycle, particularly at speed. The smaller gyroscopic effect of the front wheel of this recumbent means that you should ride with both hands on the hand grips and pay attention to your course.

**Choice of pedals:** Assuming you have prior experience and second nature familiarity with clipless pedals, we highly recommend the use of clipless pedals. The forward, relatively high position of the pedals on a recumbent bicycle maximizes the benefits of their use.

However, if you are not experienced and very familiar with clipless pedals, do not attempt to learn recumbent riding and clipless pedal use at the same time. (See section 4 F of the Cannondale Owners Manual and the instructions from the manufacturer of your clipless pedal system).

The same advice is given for use of pedals with toe clips and straps: Do not attempt to learn recumbent riding and toe clip & strap use at the same time (See section 4 E of the Cannondale Owners Manual).

Do not use flat, slippery plastic pedals or wear slippery-soled shoes. You do not

want your foot to slide off, strike or catch the ground and cause injury to your foot or leg.

**Passengers:** Do not carry any passengers, including children, on this recumbent bicycle. The extra weight of passengers could compromise steering or braking performance. A passenger could also compromise control.

**Off-road riding:** These are not mountain bikes. The Easy Rider is similar to a conventional hybrid in terms of off-road capability. (See section C of the Cannondale Owners Manual) These bikes work well on roads or bike paths that are relatively smooth and hard packed, such as cinders, good dirt roads and "rails to trails" paths. These bikes are not intended or designed for off-road use, such as trails, "single track" with logs, rocks, roots, or loose dirt.

Recumbents are further limited in the complex and ever changing terrain of off-road riding because the recumbent rider has very little ability to use two techniques that are fundamental to mountain biking: shifting weight and use of the legs to absorb shock. For these reasons do not jump a recumbent, on or off the road.

Recumbents also have a lightly loaded front tire that will be more likely to slide out or slip than the tire of a conventional bicycle.

**Riding in traffic:** See Fig. 1 for a generalized look at your eye height relative to a conventional bicycle and a typical passenger car. On the Easy Rider, you may sit slightly lower than on a traditional bicycle, but still high enough to make eye contact with automobile drivers. You will need to use caution, adapt and practice this new position, just as you would when driving a sports car one day and a tall four wheel drive the next.

Note that the front wheel of this recumbent sticks out further than the front wheel of a conventional bicycle. You are sitting further back on the recumbent bicycle.



Use care "sticking" the front wheel out into a roadway, particularly when you enter an intersection.

**Rearward vision:** On a conventional bicycle, a rider can stand up on the pedals and swivel the upper torso around to look to the rear. This swiveling motion is more limited on a recumbent. We recommend your practice riding include learning to both turn your head and use a rear view mirror. We have included a rear view mirror as original equipment. Adjusted for the rider and used properly this mirror can reduce risk but not eliminate risk.

**Pedaling technique:** On the Easy Rider, you will be able to use more leg power than on a traditional bicycle, because you can push against the seat back, much like using a leg press machine at a gym. Be careful not to overpower and injure your knees, particularly before your body becomes used to the new riding position. Our advice? Use lower gears, and spin, spin, spin.

On a conventional bike you can briefly use a gear that is too high by getting out of the saddle for a few strokes, using gravity and body weight. We often do this after temporarily slowing the bike, or when climbing a hill. On a recumbent you cannot get out of the saddle. Our advice? Anticipate changes in speed and terrain, and shift to lower gears early.

On a conventional bike you will also pull against the handlebars as you push on the pedals. On a recumbent you can push against the seat back. Learn to relax your upper body and not to pull on the handlebars. This is the key to the comfort and pleasure of recumbent riding. This upper body relaxation will also minimize the small inadvertent steering corrections that often affect new recumbent riders.

**Different muscles:** The different riding position of the Easy Rider will use different muscles and different motions. You will need to train your whole body. As with any fitness program involving a new sport or new equipment, consult with your doctor regarding your fitness, start slowly, work up progressively, cross train, stretch, and listen to your body. If you feel pain, work with your retailer on adjustments and see your doctor.

## SET UP AND ADJUSTMENT

**Frame sizes:** The following is a good starting point.

Height <5' 7" (170cm)	Standard frame
Height >5' 7" (170cm) & >200Lbs (90Kg)	Large frame
Height 5' 9" - 6'10" (175 - 208cm)	Large frame

**The seat:** The Easy Rider seat assembly is adjustable in five ways.

1. The first and most basic is fore and aft adjustment of the whole assembly. See **Fig. 2 & Fig. 3**. The goal of this adjustment is to fit the seat to pedal distance to your own body size. The objective is to have your knee slightly bent when your foot

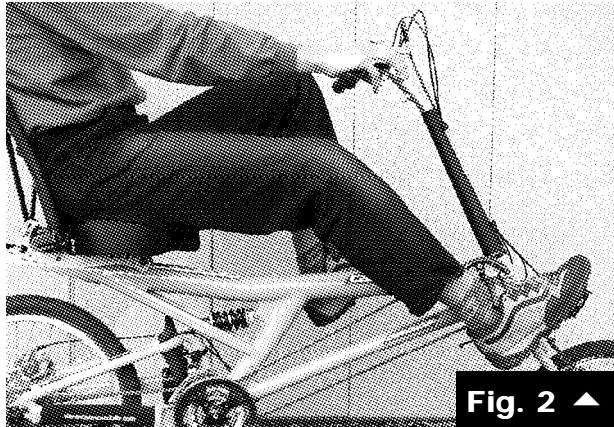

is at the forward most part of the pedal rotation. You should not bend your ankle to reach further forward. As noted in the "starting off" section above, start with a shorter seat-to-pedal distance. The seat rails are laser etched with a size scale. Note your preferred setting and save time when sharing a bike or reinstalling the seat assembly after removing it for transport.

The seat assembly is clamped in place with two quick release assemblies. See section 4 B of the Cannondale Owners Manual for detailed instructions on the proper operation of a quick release.

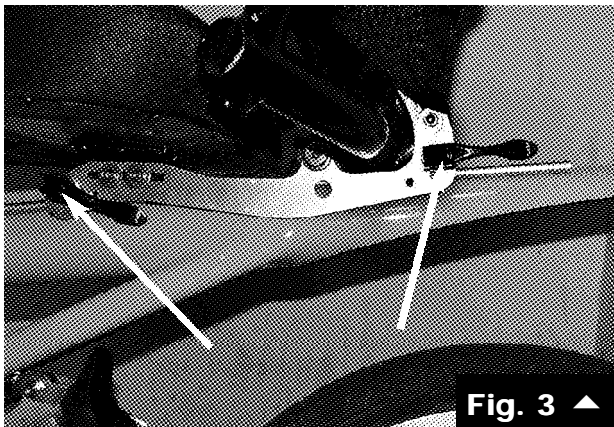

8

**WARNINGS:** It is very important that you properly adjust and firmly close both quick release seat clamp assemblies. Read and follow the instructions. If they are not properly adjusted they could slip.

Be sure to position the rear seat clamp quick release lever is positioned horizontally to maximize clearance with the rear tire through the full range of suspension travel. See **Fig. 4**. Do not adjust seat assembly further forward than minimum line. See **Fig. 5**.

Do not attempt to adjust the seat while riding.

Failure to follow these instructions could cause loss of control and injury.

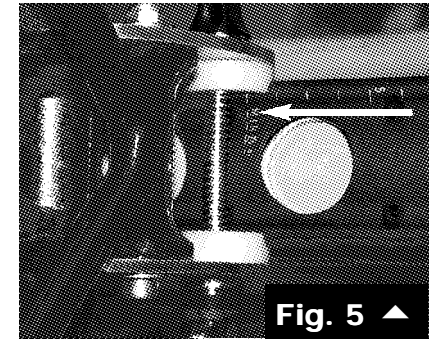
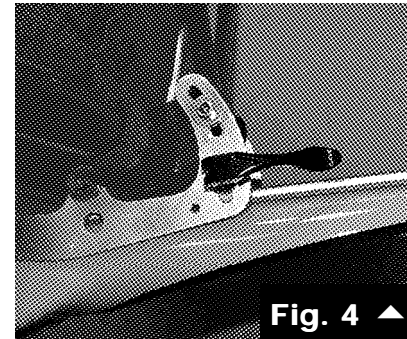

2. The second adjustment is the seat back angle. The seat back may be adjusted through 17 degrees. This adjustment is made by loosening the two bolts (one on each side) shown in **Fig. 6**. Move the seat back to suit your preference and retighten the clamp bolts. They should be torqued to **94-130 In-Lbs (8.7-10.6 Nm)** before riding. As noted in the "starting off" section above, start with a more upright seat back angle. We suggest mid position or steeper.

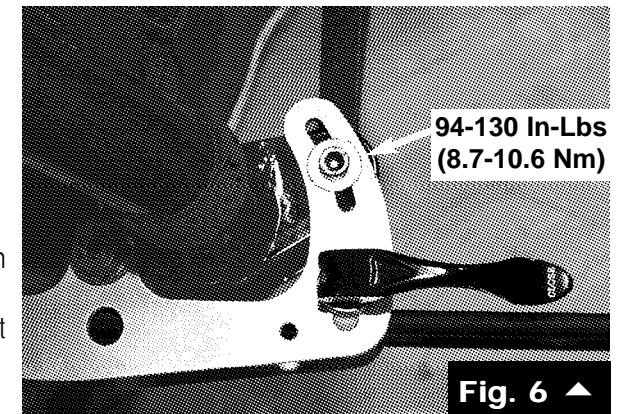

9

3-4. The third and fourth are seat base angle and seat base fore and aft adjustment. The seat base can be adjusted through 20 degrees of tilt and 30mm fore and aft relative to the seat back. This adjustment is made by loosening the four bolts (two on each side) shown in **Fig. 7**. Move the seat base to suit your preference and retighten the bolts. Torque to **77-94 In-Lbs (8.7-10.6 Nm)** before riding.

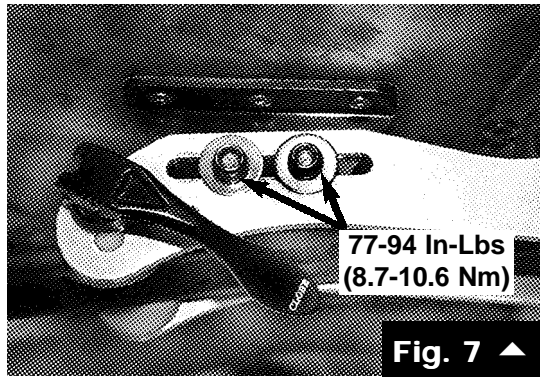

5. The fifth is the adjustment of the backrest mesh fabric tension. You may selectively loosen or tighten the webbing straps behind the seat back. See **Fig. 8**.

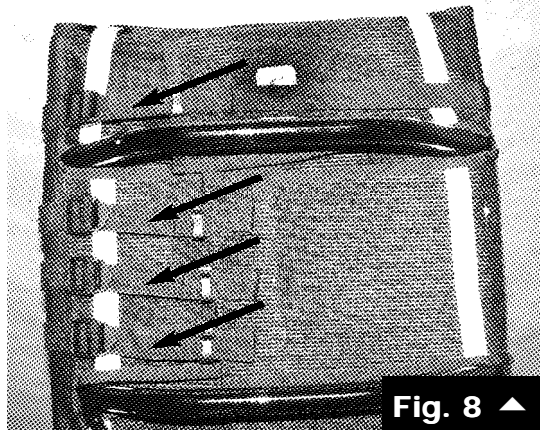

#### The handlebars and stem:

The general goal is to have your knees clear the handlebars and to have your hands slightly lower than your shoulders. The height of the handlebars can be adjusted. See **Fig. 9**. Do not adjust the stem above the minimum insertion line. (See section 3 A 3 of the Cannondale Owners Manual) As you make adjustments and do short test rides, be sure to do some slow maneuvering in tight circles so that you can strike the right personal compromise between knee clearance and arm comfort. Retighten stem clamp bolts. Torque to **77-94 In-Lbs (8.7-10.6 Nm)** before riding.

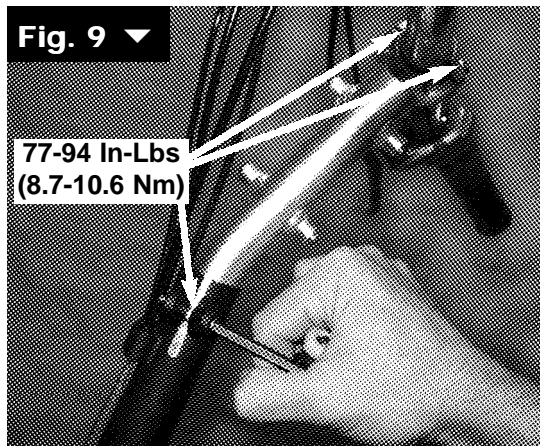

The handlebars can be rotated in the stem. Because the handlebars have a curve or sweep, rotation will allow you to fine-tune your reach. Retighten handlebar clamp bolts. Torque to **77-94 In-Lbs (8.7-10.6 Nm)** before riding.

Other stem choices: The standard Cannondale Easy Rider stem has 70mm offset. Bike E offers a "straight" stem with no offset, and a 50mm offset stem. Both Bike E stems will fit the Easy Rider.

## MECHANICAL ADJUSTMENTS

This section makes no attempt to be a comprehensive manual on bicycle mechanics. If you are not a very experienced mechanic we urge you to bring your bicycle to an authorized Cannondale retailer where a professional mechanic can do the job right. In addition to putting yourself at risk, poorly done mechanical work may void your warranty. This section covers design features unique to the Easy Rider recumbent, and is intended primarily for the Authorized Cannondale Retailer performing the assembly and adjustments.

**WARNING: All Cannondale bicycles must be fully assembled and adjusted by an Authorized Cannondale Retailer before delivery to the customer.**

Your Cannondale dealer should have correctly performed all adjustments before the sale of the bicycle. If you feel that your Easy Rider is out of adjustment, please take the bike to your Authorized Cannondale Retailer.

**Holding the bike in a work stand:** There are several alternatives. You may use an oversize clamp kit for the popular Park work stands. The down tube is 1 1/2" diameter and is right at the limit for the standard Park clamp. If you clamp the down tube you may pinch the cables. You may clamp the left-hand chainstay or the seat back upright. If you clamp the left-hand chain stay or the seat back upright get help and be careful, as the weight of the bike will be cantilevered. Use care with any bike stand not to clamp so hard as to dent the tube.

**Suspension set up:** You will need to understand some suspension terminology in order to follow these instructions and get the most performance from your bicycle.

**Travel:** The total distance that the suspended wheel can move.

Spring rate: The force needed to compress the spring one inch. Heavier people need a higher spring rate than lighter people.

Preload: The initial amount of force placed on the spring. Preload is used to change or adjust spring rate and therefore sag.

Sag: The amount that the suspension compresses with the rider sitting on the bike in a normal position. It is usually expressed in percent of suspension travel. Sag allows the wheel to travel downward to follow the terrain.

**Easy Rider fork:** The Easy Rider fork features the patented HeadShok telescoping steerer tube assembly that uses 88 needle bearings for smooth, responsive suspension action. The fork blades are TIG-welded 6061-T6 aluminum for a lightweight but stiff fork structure for precise steering. These forks are not disc brake compatible. Do not attempt to fit disc brakes with any clamps and/or adapters.

The Easy Rider fork includes the MC60 cartridge that offers 60mm of travel using the Advanced Spring System's coil spring / MCU combination. The cartridge also features a mechanical air damper that controls the compression and rebound speed of the spring.

## **FORK WARNINGS**

**If the suspension fork ever begins to make “knocking” or “clunking” noises, or if it ever shows an unexplained increase in travel, or looks like it is extended farther than it was originally, stop riding the bike and bring it to a Cannondale dealer for inspection. Possible indications of a problem are:**

**An increase in the fork’s extension or travel.**

**A stretched-out fork boot.**

**A stretched or strained front brake cable.**

**“Knocking” or “clunking” noises coming from fork.**

**If any of the above symptoms are ignored, the result could be a separation of the fork from the bicycle frame. Separation of the fork could lead to an accident, with risk of serious injury or death.**

## **FORK WARNINGS CONTINUED**

**If your bike has suspension, the increased speed you may develop also increases your risk. When braking, the front of a suspended bike dips. You could have a bad accident if your skill is not up to handling this system. Get to know how to handle your suspension system well before trying any very fast biking.**

**Likewise, suspension will increase handling capabilities and comfort of your bicycle. This enhanced capability may allow you to ride faster. But do not confuse the enhanced capabilities of a suspension bike with your own capabilities. Increasing your skill will take time and practice. Proceed carefully until you are sure you are competent to handle the full capabilities of your bike.**

**Use only brakes designed to be mounted to existing cantilever bosses. Do not attempt to add any brake mount or use any brake device that requires adapting the fork’s existing brake mounts. Altering or adapting existing brake mounts or installing new brake mounts will void the fork’s warranty and may result in structural failure of the fork. Structural failure of the fork will result in loss of control of the bicycle, placing the rider in danger of serious injury or death.**

**Preload Adjustment:** Before the bike is ridden, front and rear spring preload must be adjusted to rider weight. If too much preload is applied, the suspension will be stiff and unresponsive; too little preload and the rider may feel “bouncing” while climbing or accelerating hard, and may tend to bottom out the shock (compress it to the limit of its travel) on large bumps.

The HeadShok front suspension uses a steel coil and MCU spring and a mechanical air damper, also known as a shock absorber. These components are hidden from view inside the HeadShok. To adjust the front suspension spring preload, first use a 6mm hex wrench to remove the stem extension tube. You will now see a hole in the center of the top of the fork. Insert a 4mm hex

wrench to engage the preload adjusting screw. Turn the screw clockwise to increase preload, resulting in a higher spring rate and less sag. Turn the screw counterclockwise to reduce preload, resulting in a lower spring rate and more sag. See Fig. 10.

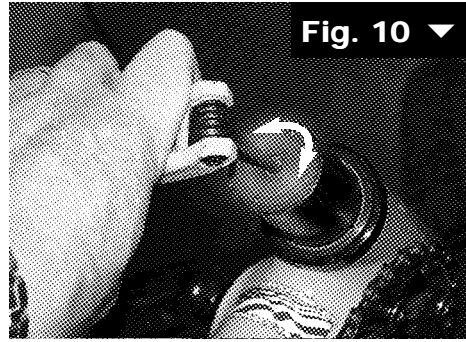

The preload screw puts pressure on the spring. Turn the screw counterclockwise to the point where you feel that the screw is not compressing the spring. This is your starting point for adjustment. Now count turns clockwise per the chart, Fig. 13. After adjustment is made, reinstall the stem extension tube, making sure that it is seated flush against the headset seal with the bolts on the left side. Torque to 77-94 In-Lbs (8.7-10.6 Nm). See Fig. 11.

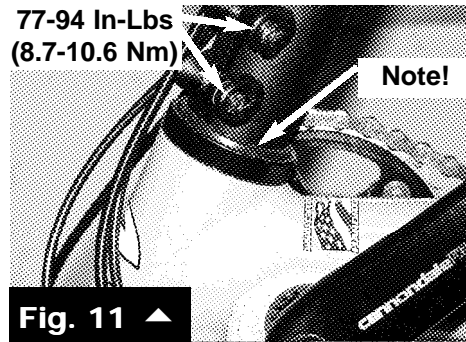

**WARNING: Do not use the stem extension tube to adjust handlebar height. The stem extension tube must always be clamped in place fully seated against the headset top seal with the bolts on the left side. If the stem extension tube is not properly clamped, it may break with risk of serious injury to the rider.**

The rear suspension uses a coil-over shock, meaning that a steel coil spring surrounds the oil damper, also known as a shock absorber. To adjust the rear suspension spring preload, you will turn the spring preload ring. Turning the ring clockwise increases preload, resulting in a higher spring rate and less sag. Turning the ring counterclockwise decreases preload, resulting in a lower spring rate and more sag. See Fig. 12.

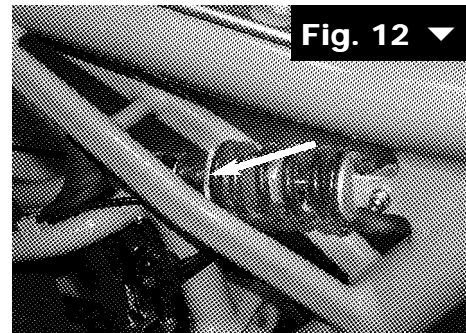

With the rear wheel off the ground, turn the spring and preload ring

counterclockwise until the preload ring is not touching the spring. Now turn the preload ring until it firmly contacts the coil spring but does not compress it. This is your starting point for adjustment. Now turn clockwise per the chart, Fig. 13.

**Approximate number of turns of spring preload required for the recommended 40% sag (About 25mm sag front and 30mm sag rear).**

Note: this will vary with rider height due to change in weight distribution. This is a very **soft & compliant** setup for use on uneven surfaces - riders on smooth roads may favor a harder suspension set up. If so, increase the number of turns of spring preload.

Bike size	Rear shock		Fork		Rider Kg
	Standard	Large	Standard	Large	
Rider Lbs					
<140	*	***	1	*****	<64
140-160	1	***	3	*****	64-73
160-180	2	1	5	1	73-82
180-200	3	1	7	3	82-91
200-220	4	2	9	5	91-100
220-240	**	2	****	7	100-109
240-260	**	3	****	9	109-118
260-280	**	4	****	11	118-127

- \* Use 700 lb/in x 1.57 spring - available from Fox
- \*\* Use 1050 lb/in x 1.60 spring or go to LARGE size bike providing you are over 5'7" (170cm)
- \*\*\* Use 900 lb/in x 1.60 spring or STANDARD size bike providing you are under 6'0" (180cm)

**Warning - Do not exceed 5 turns of preload on the Fox rear shock**

- \*\*\*\* Use blue spring (available from your Cannondale retailer) in fork or go to large size bike providing you are over 5' 7" (170cm)
- \*\*\*\*\* Use green spring (available from your Cannondale retailer) in fork or go to standard size bike providing you are under 6' 0" (180cm)

Note: A firmer red fork spring is also available for the fork from authorized Cannondale retailers

Cannondale Part #	Description	Spring Color
HD110/GRE	Soft fork spring	Green
HD110/BLU	Medium fork spring	Blue
HD110/RED	Hard fork spring	Red

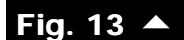



For the majority of riders the standard springs, once preloaded for a rider, will work fine. Some riders with different preferences may need different springs. As the chart indicates, there are additional springs available from Cannondale for the HeadShok fork and from Fox for the rear shock. We urge you to have your retailer change springs.

**Do not attempt to adjust the preload or touch the spring or swingarm while seated or riding. Suspension movement could cause you to pinch or injure your fingers. Keep your hands away.**

**HeadShok scheduled maintenance:** It is recommended that you take your Easy Rider to your Cannondale retailer for a fork tune up every 6 months or 60 hours of riding. Your fork is a high performance suspension system and needs regular inspection, lubrication, and maintenance. The mechanic will check the following items and service as necessary. Between tune ups, you will also want to check your fork as outlined below.

**Frame and Fork:** Once a month, or every few rides, clean and inspect the entire frame and fork for any dents, cracks, or other damage. If any damage to the frame or fork is found, do not ride the bicycle. Have the damage inspected by a Cannondale retailer.

**Headset Bearings:** Periodically, particularly after the bicycle is exposed to a lot of water (rain, mud, or washing) a few drops of lightweight oil (such as Pedro's Syn Lube) should be smeared around the upper headset bearing (located just below the stem). The rubber seal in the top of the bearing must be kept lubricated, as it protects the headset cartridge bearings from contamination by water and dirt. Failure to keep the headset bearing lubricated will result in premature bearing wear.

**Suspension Fork Boot:** Frequently inspect the rubber boot at the base of the head tube for tears, cuts, or broken zip ties that could allow contamination. The fork boot protects the needle bearings and bearing races from water, dirt, and other contaminants. Make sure that the shifting and brake cables have not rubbed a hole in the boot. If the cables are rubbing on the boot, you should re-route them to eliminate the contact. Your Cannondale retailer can help you with this procedure.

If the boot is damaged in any way, it must be replaced immediately. Boot replacement requires the suspension fork be removed from the frame using

special tools, so only an experienced bicycle mechanic at a Cannondale retailer should perform this job. Damage to the fork due to contamination by water or dirt will not be covered under warranty.

**Inner Steerer Tube:** Several times a year, or if the suspension boot has been damaged, or if the fork has taken a large or unexpected impact, you should inspect the inner steerer tube beneath the boot. Before proceeding, make sure that you have two replacement zip ties to reattach the HeadShok boot. These should be available from your Cannondale retailer. Cut both old zip ties off of the boot and pull the boot up off of the lower boot mount and down off of the lower collar. Clean the area inside the boot of any dirt and old grease. Inspect the inner races and the steerer tube for corrosion, cracks, or a bent steerer tube. Also be sure to slide the large O-ring bottom-out bumper up off of the crown and carefully check this area.

If there are any cracks on the steerer assembly or if it is bent at all, the fork must be replaced immediately. **DO NOT CONTINUE TO RIDE.** If rust, pitting, or corrosion is present on the steerer tube, you should take the fork to a Cannondale retailer for inspection and to evaluate the amount of structural damage that may have resulted.

**WARNING: Serious, structural corrosion on the inner steerer tube of a HeadShok fork will decrease the useful life of the fork. Corrosion or cracks on the steerer tube, or a bent steerer tube, may lead to the failure of the fork, which could cause an accident with attendant risk of injury or death. HeadShok forks that show signs of such structural damage in the steerer tube must be replaced immediately.**

After completing inspection of the HeadShok steerer tube assembly lightly coat the exposed length of the inner steerer tube and bearing races with a good quality light bicycle grease, such as Finish Line White Teflon grease, Slick 50 One Grease, or Royal Purple grease (Cannondale part # HD225/). Be sure to slide the large O-ring bottom-out bumper up from the crown and thoroughly grease under the O-ring at the junction between the bottom of the inner steerer tube and the fork crown.

Replace the boot onto the lower collar of the HeadShok telescoping assembly and to the top of the fork crown. Reattach the boot with two zip ties. Make sure that the zip ties are secured tightly.

**Needle Bearing Lubrication:** The needle bearings (which provide the smooth travel of the HeadShok suspension system) inside all Easy Rider forks should be lubricated every 6 months or 60 hours of riding. This procedure requires partial disassembly of the suspension fork, and therefore must be performed only by an experienced bicycle mechanic at an Authorized Cannondale retailer.

**HeadShok warranty:** All HeadShok forks and their internal assemblies are warranted against manufacturing defects in materials and/or workmanship for a period of one year from the date of original retail purchase. Not covered under warranty is damage resulting from improper adjustment or maintenance, lack of maintenance, crashes, or use judged to be excessive or abusive. Please see your Cannondale Bicycle Owner's Manual for more complete warranty information.

**Fox rear shock service and warranty:** See the Fox Shox Owners Manual included with your Easy Rider regarding the Fox "Vanilla" shock.

**Tire choice:** Standard tires for the Easy Rider are MAXXIS "Hookworm". This odd name comes from the fact that these tires were developed for a segment of the BMX market. We believe that they are ideal for the Easy Rider. They are very tough, minimizing the risk of flats. They have high air pressure capability, necessary for use on the rear, which will carry approximately 70% of the weight. They have a round profile, an important characteristic for smooth, predictable "turn-in" to a corner and mid-corner steering corrections. This round profile is particularly important on the front. Note that a "pointed" or raised center profile tire will have quick, uneven "turn-in" characteristics. We believe that any hypothetical reduction in rolling resistance is not worth the adverse effect on handling. In our testing these tires had low rolling resistance. If you choose to change to another make and model of tire we recommend you consult with an experienced bicycle retailer about weight distribution and these characteristics.

**Rear tire pressure:** This recumbent carries much more weight (approximately 70%) on the rear tire than on the front tire. The MAXXIS Hookworm 20 x 1.95 (ISO 406) rear tire should be inflated to approximately 2/3 of your body weight in pounds in PSI (pounds per square inch). You may inflate the rear tire up to the 110 PSI listed on the tire manufacturer's label, on the sidewall of the tire. Let's say you weigh 100 pounds; use 65 PSI. Let's say you weigh 200 pounds; two thirds of 200 is 130, and the maximum inflation pressure is 110 PSI, so use 110 PSI.

For metric folks, use 10 % in BAR of your body weight in Kg up to the maximum inflation pressure of 7.5 BAR. Let's say you weigh 50 Kg, use 5 BAR. Let's say you weigh 100 Kg, ten percent of 100 is 10, and the maximum inflation pressure is 7.5 BAR, so use 7.5 BAR.

**Front tire pressure:** When inflating the front tire of the Easy Rider DO NOT follow the pressure recommendation on the tire's sidewall. Instead follow these instructions and the warning on the rim, reproduced below.

English units: The MAXXIS Hookworm 16 x 1.95 (ISO 305) front tire should be inflated to 1/3 of your body weight in PSI.

Metric units: Use 5 % in BAR of your body weight in Kg. Therefore, if you weigh 50 Kg, you should inflate the front tire to 2.5 BAR. If you weigh 100 Kg, you should inflate the front tire to 5 BAR.

**WARNING**

**TO HELP AVOID SERIOUS OR FATAL INJURY:**

Inflate front tire to 1/3 (one-third) of your body weight in PSI. Examples:

- body weight 100 lbs use 33 psi
- body weight 200 lbs use 66 psi

Higher-than-recommended pressure in the front tire will decrease braking and cornering ability and increase risk of an accident. See the Recumbent Owner's Manual Supplement.

Inflate front tire in BAR to 5% (0.05) of your body weight in Kg. Examples:

- body weight 50 Kg use 2.5 BAR
- body weight 100 Kg use 5.0 BAR

Lower pressure in the front tire is required because of the low percentage of weight, approximately 30%, on the front tire. As with any bike, lower tire pressures give better grip on wet, unpaved, cobbled or loose surfaces. The grip comes at the price of increased rolling resistance. If you have any difficulty following these important instructions please see your retailer.

**Shifter positioning:** Rider position on a recumbent makes it difficult to see the drive train. We use modern index shifters that have gear position indicators. We suggest that you rotate the shifters so that the rider can see the gear position indicators while riding.

**Shifter choice:** Think twice about using "Rapidfire" style shifters in place of twist or "Grip Shift" type shifters. The under handlebar levers on "Rapidfire" style shifters will reduce knee clearance and cause you to raise the stem more than you might wish to.

**Mid-drive/Mid-drive bearing:** The Easy Rider uses a mid-drive system. The front chainring is simply a single crankset. It is connected by the front chain to the inner chainring of a crankset without crankarms. This special crankset has 4

chainrings and is the heart of the mid-drive system. The inner chainring is driven by the front crankset via the front chain. The outer three chainrings are used exactly as the chainrings on any triple crankset conventional bicycle. The drivetrain is exactly as on any conventional bicycle.

The mid-drive crankset spins on a two special bearings pressed into a recess on the back of the crankset. These bearings ride on a special shaft threaded into the drive side of the mid-drive bottom bracket. The bearings are sealed and maintenance free, but if new ones are needed they can be replaced. To do so, remove the M6 bolt on the front of the mid-drive crankset. To replace it, torque the bolt to **77-94 In-Lbs (8.7-10.6 Nm)** before riding.

**Front chain tensioner:** The front chain is tensioned using the same patented bottom bracket eccentric adjustment mechanism used in Cannondale tandems. Your Easy Rider will be delivered with this mechanism properly adjusted. If you think that the front chain seems to have excessive slack, let your retailer take a look. A properly adjusted front chain will not bind or feel tight at any point in a rotation of the crankset and will not have excess slack in the chain.

Adjustment: As the chain wears and stretches, use the eccentric to return the chain to a maximum of 1/2" of vertical chain deflection between the two cranks.

1. Using a 4mm hex wrench, turn the socket head bolt on the right side of the eccentric counter-clockwise to loosen the eccentric assembly. If the bolt has been previously installed tightly it will be necessary to tap the head of the bolt with a mallet to free the wedge (much like a stem wedge) assembly.

2. Once the assembly is free, use a bottom bracket pin tool such as the Park

SPA-1 (green) to rotate the eccentric until proper chain tension is obtained. Secure the assembly in its new position, centered in the frame, by tightening the hex bolt clockwise to **60 In-Lbs. (6.75 Nm)**. See **Fig. 14**. Note that the right crank arm has been removed for clarity.

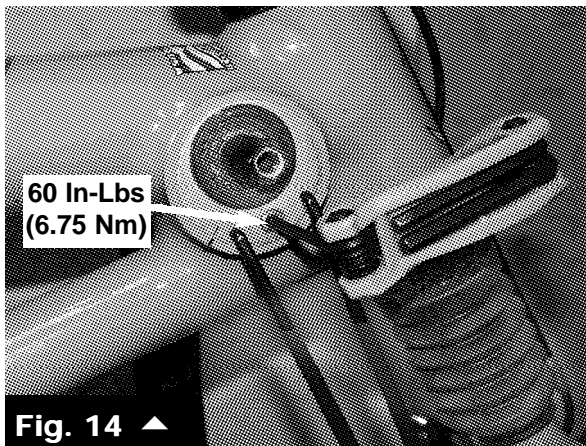

If for any reason the eccentric must be removed from the bike or replaced, it is very important that the outer surfaces (including under the wedge) are thoroughly coated with anti-seize compound or greased before re-installation. Also, the eccentric **MUST** be re-installed with the head of the hex bolt on the right side of the bike to assure that the bottom bracket is installed the correct direction.

**Chainring bolts:** should be periodically checked for tightness, particularly the five inside bolts that secure the two innermost chainrings. Torque these bolts to **110 In-Lbs (11Nm)**.

**Front derailleur adjustment:** It is very important that the front derailleur lower limit screw be set accurately to avoid the chain accidentally shifting from the inner chain wheel (the third chain wheel in, also known as the "granny") onto the primary drive chain (which turns the fourth chainring in).

**Brake set up:** Please see enclosed brake manufacturers instructions. Set up is as on a conventional bike, with one exception. The front "V" brake guide tube, often called the "noodle", is a special part. This special noodle has a tight 120 degree radius, rather than the standard 90 degrees. This additional bend, combined with precise casing length of 11-3/8 inches (29cm) and careful casing routing prevents the front brake cable and casing from conflicting with the right pedal or crank. The front brake casing should have minimal slack when the fork is fully extended. See the photos inside the front cover of this booklet for a guide to cable routing.

## CARRYING STUFF

**The tubing on the back of the seat back:** is 22.2mm (7/8") outside diameter. This is standard handlebar diameter. You can use many handlebar bags designed to fit handlebars. Follow the bag manufacturer's instructions.

**Day packs/Back packs/Hydration packs:** fit nicely over the seat back. Be sure both shoulder straps are inboard of the vertical frame members. Attach the waist belt, and any sternum strap, around the seat back to keep the pack stable. Be sure that no straps hang low enough to tangle in the rear wheel.

**Panniers:** A rack will be available that attaches to the base of the seat assembly. The seat assembly is pre drilled and tapped (standard M6) to accept this pannier rack. This rack will accept a pair of medium panniers, one on each

side. The advantage of this design is that the weight of the panniers is centered with your own weight.

**WARNING: Do not strap or lash anything directly to the extended top tube/rear fender. This is a round, slick surface that is close to the wheel. It is not a safe place to carry gear. Packages or cargo could fall into the rear wheel and cause an accident, with risk of serious injury.**

## ACCESSORIES

**Lighting:** Must be added if you ever ride at dawn, dusk or night. See section 2 F of the Cannondale Owners Manual. Reflectors alone are not adequate for night riding. Note that the seat back struts are a good place to add a flashing rear strobe light designed to be mounted on a conventional seatpost.

**Kickstand:** Cannondale includes one. Don't forget to put it up before riding.

**Water bottles:** The Easy Rider stem has standard bosses for two water bottle cages on the stem extension tube. If more capacity is needed we suggest a bladder system suspended from the seat back.

**Fenders:** Front: Look for 16" front fenders, Bike E fenders work fine. Rear: A small "shorty" fender used on some mountain bikes fits the Easy Rider and is available from Cannondale, part # KF032/. Want something larger? Look for 20" fenders. The swing arm offers good clearance. As with many bikes, fitting fenders will require adaptation and/or fabrication by a careful professional mechanic who considers suspension travel, disc brake clearance and vibration.

**Fairings:** Can be added. At this writing Cannondale does not make them or sell them. Seek professional installation.

**Chain guard:** The Easy Rider frame has fittings resembling water bottle bosses for a chain guard. Cannondale has plans to have one made to fit the Easy Rider in the future. Please contact your retailer regarding availability.

**Indoor trainers:** See your retailer and consider models designed to fit a recumbent like the Bike E.

## TRANSPORTATION

**On a car:** You may need to use a tandem type rack. One design you may wish to consider is the "Topper" rack ([www.Atoc.com](http://www.Atoc.com)). One of the Topper designs allows one person loading of a longer, heavier bike with a pivoting system. These systems fit Thule and Yakima roof racks. We strongly recommend that you remove the seat assembly prior to transportation on top of a car. The seat assembly will add considerable aerodynamic drag. This drag will increase fuel consumption, wind noise and stress on your rack.

**In a car:** Consider removing the seat assembly. Loosen the two quick releases and slide the seat assembly forward and off the seat rails. Removing this bulky part will ease packing. When you reinstall the seat assembly on the seat rails be sure that radius on each plastic slide lines up with the radius on each side of the seat rail. **See Fig. 15.** See also SET UP AND ADJUSTMENT section above regarding seat adjustments.

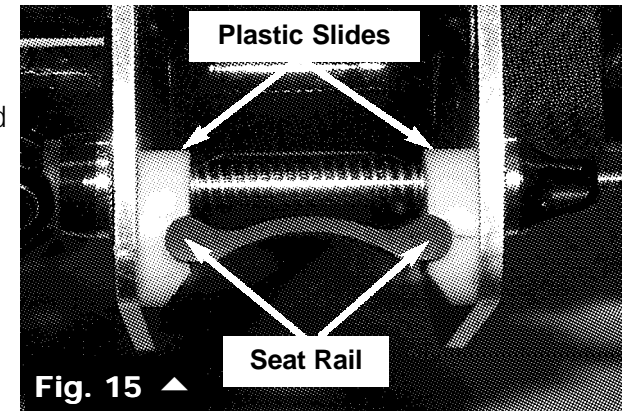

Fig. 15 ▲

## REFERENCES

The standard for recumbent information, from eclectic to mainstream: RCN, Recumbent Cyclist News, P.O. Box 2048, Port Townsend WA, 98368 or [www.recumbentcyclistnews.com](http://www.recumbentcyclistnews.com)

## **CANNONDALE WARRANTY**

Your Cannondale East Rider frame is warranted against manufacturing defects in materials and/or workmanship for the lifetime of the original owner. Under this warranty we will repair any defective frame or, at our discretion, we will replace a defective frame with the same or comparable model (due to product evolution). See the standard Cannondale Owner's Manual for more details.

All other components, including HeadShok forks, suspension parts, frame fixtures and finishes (paint and decals) are warranted against manufacturing defects in materials and/or workmanship for a period of one year from the date of purchase.

For complete information regarding your Cannondale Limited Warranty, please refer to your Cannondale Bicycle Owner's Manual.

## **CONTACT INFORMATION**

For warranty related questions or for more information on this or any Cannondale product, please feel free to contact us.

USA and Canada: (800) BIKE-USA  
Europe (EC): (31) 541-573580  
Japan: (81) 722-99-9399  
Australia: (61) 2-9979-5851

<http://www.cannondale.com>  
[custserv@cannondale.com](mailto:custserv@cannondale.com)

**EASY RIDER**<sup>™</sup>  
*by cannondale*

